

# ARO Baffle V1

Acoustic Ceiling Baffle

filzfelt



## ARO Baffle V1 works all the angles.

This unexpected baffle features 100% Wool Design Felt on a thin 10mm-thick acoustic substrate which is cut and folded into a symmetrical 'V.' The baffle comes in customizable length and choose from over ninety colors. And although suspension hardware is a necessity, it doesn't need to be the center of attention. The flexible suspension and mounting options of ARO Baffle V1 are sleek and minimal while also making installation a breeze.

ARO Baffle V1 was designed by Architecture Research Office (ARO), a New York based firm dedicated to architecture that unites beauty and form with strategy and intelligence.

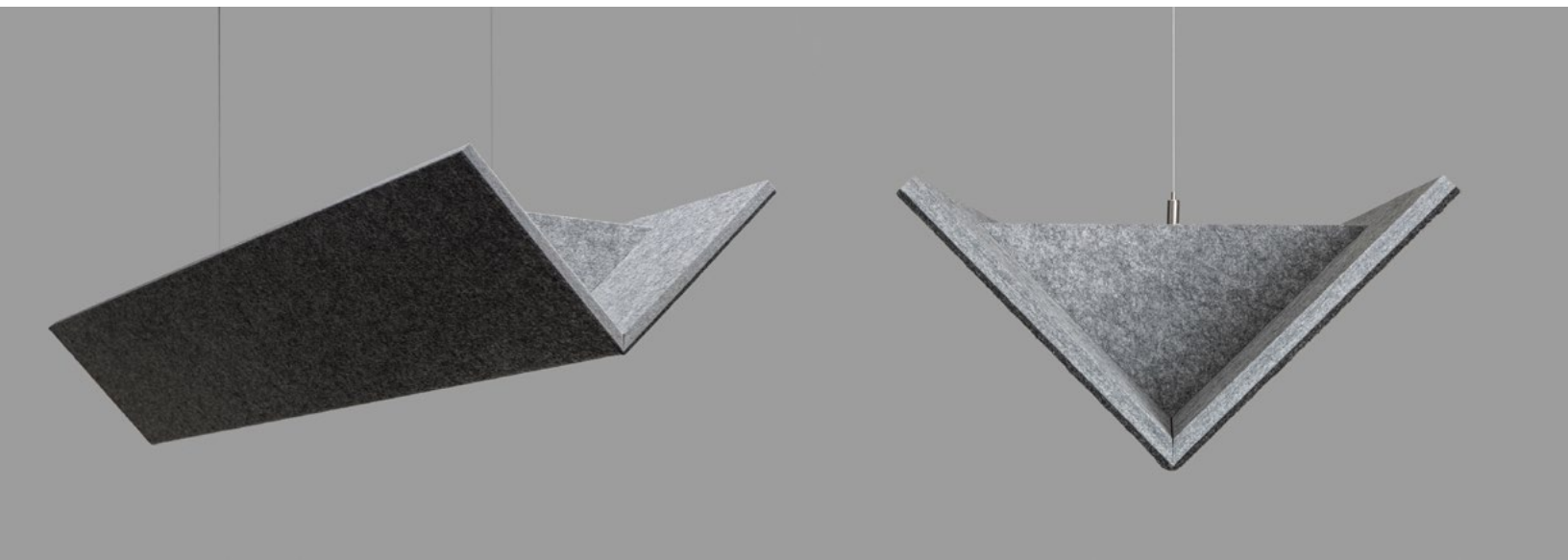



"We strive to convey a sense of calm, warmth, and joy in our product designs as well as through the architecture we design. We take inspiration from both material expression and functionality. We work to elevate spaces through careful attention to detail and use, and to emphasize the responsible use of materials and seek to balance beauty and strategy through design, pattern and texture."

– Architecture Research Office, designers of ARO Baffle V1

## Suspension Options



Suspension Cable



Suspension Rod

## Ceiling Attachment Options for Suspension Cable



None

No Ceiling Attachment Hardware Provided Unless Otherwise Specified



Ceiling Mounting Plate

Ceiling Mounting Plate includes Mounting Plate with Cable Gripper (ceiling fasteners not included)



ACT Grid Clip

ACT Grid Clip with Cable Gripper Attaches to Standard Acoustical Ceiling Tile (ACT) Ceiling Grid—Available for 9/16" (1.4 cm) or 15/16" (2.4 cm) Grid Sizes

For details of suspension + ceiling attachment options, please contact FilzFelt Customer Service

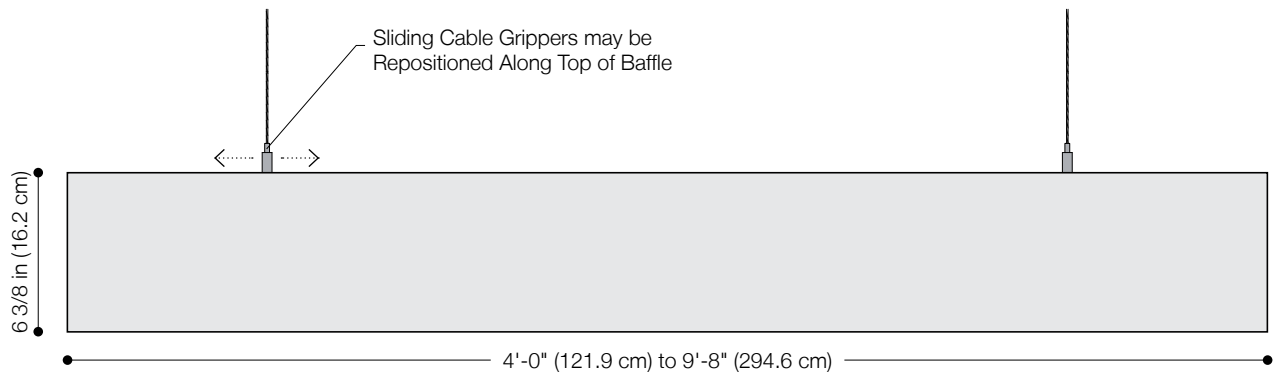

**Front Elevation**

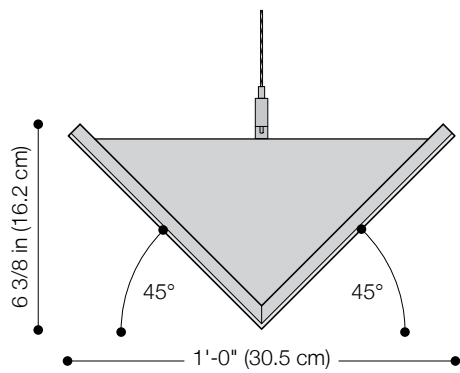

**Side Elevation**

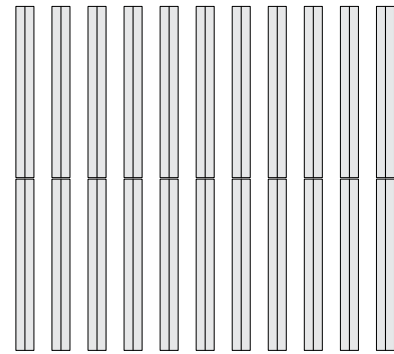
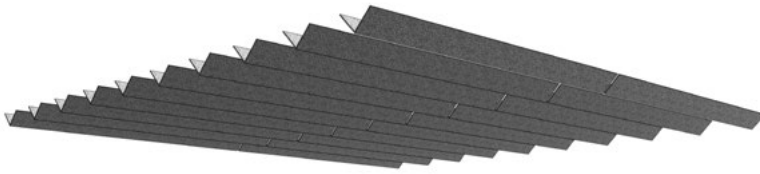

**Suggested Configuration 1**

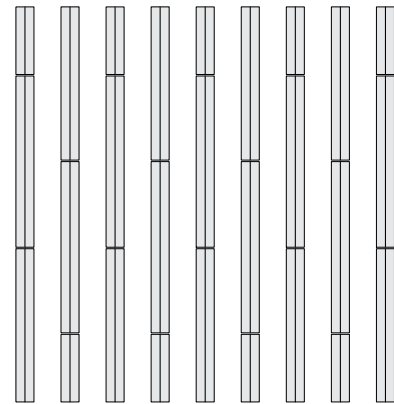
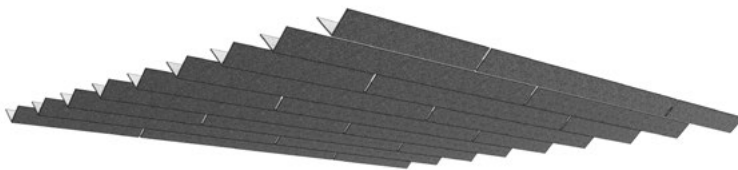

**Suggested Configuration 2**

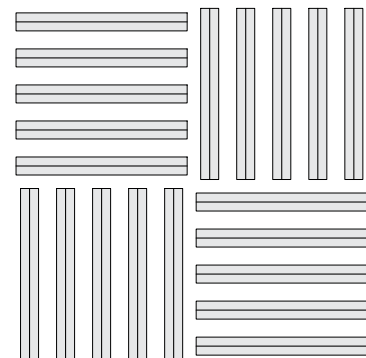
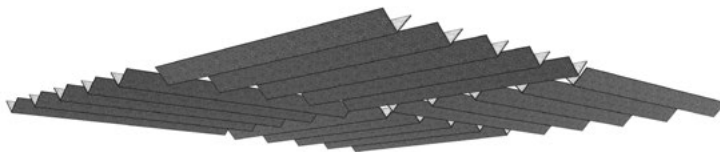

**Suggested Configuration 3**

<b>Product</b>	ARO Baffle V1
<b>Designer</b>	Architecture Research Office
<b>Content</b>	100% Wool Design Felt + Akustika 10 Substrate (60% post-consumer recycled content)
<b>Length</b>	Minimum: 1'-0" (30.5 cm) Maximum: 9'-8" (294.6 cm)
<b>Width</b>	1'-0" (30.5 cm)
<b>Height</b>	6 3/8 in (16.2 cm)
<b>Suspension Options</b>	Suspension Cable Suspension Rod
<b>Ceiling Attachment Options for Suspension Cable</b>	None Ceiling Mounting Plate ACT Grid Clip
<b>Durability</b>	Contract
<b>Lead Time</b>	Made to order and certain lead times will apply
<b>Installation</b>	Install with two suspension drops included per baffle for suspended options or ceiling attachment hardware for ceiling mounted. Sliding cable grippers and suspension rods may be repositioned along track in top of panel and optional ceiling attachment options include ceiling mounting plate and ACT grid clips. Suspension cables or rods come in 3'-0" (91.4 cm) length and additional length is available for an upcharge. Actual ceiling connection depends upon ceiling type and ceiling fasteners not included.
<b>Unistrut Installation</b>	Suspension options may be suspended from Unistrut Metal Framing System provided by others. For more information, please contact FilzFelt Customer Service.
<b>Maintenance</b>	Vacuum occasionally to remove general air-borne debris. Should soiling occur, spot clean with mild soap and lukewarm water. Avoid aggressive rubbing as this can continue the felting process and change the surface appearance of the felt. Refer to Product Maintenance and Cleaning Guide for detailed care instructions.
<b>Variation</b>	Wool felt is a natural material and color variation and inclusions of natural fiber on the surface are evidence of the 100% natural origin of the material. Product color is only indicative, as it is not possible to assure consistency of color in a natural product due to the natural color of raw wool and absorption of dyes. Color matching cannot be guaranteed on shipments and variation will be more pronounced beyond the normal commercial range.
<b>Environmental</b>	100% Wool Design Felt is 100% biodegradable/compostable and Akustika 10 contains minimum 60% post-consumer recycled content and is 100% recyclable Contains no formaldehyde, 100% VOC free, no chemical irritants, and free of harmful substances 100% Wool Design Felt and Akustika 10 contribute to LEED® Download Declare Label Oeko-Tex® Standard 100 Certified Product Class II (100% Wool Design Felt + Akustika 10 Substrate) Meets VOC test limits for the CDPH v1.2 method
<b>Acoustics</b>	ASTM C 423: NRC – 0.50, SAA – 0.51
<b>Colorfastness to Light</b>	Class 4–5 (40 hours)
<b>Colorfastness to Crocking</b>	Class 3–4 (wet), Class 4–5 (dry)
<b>Flammability</b>	Test reports available upon request





# Standard Colors

## 100% Wool Design Felt

							
487 Pfirsich	023 Koralle	945 Drachenfrucht	221 Himbeere	136 Weinrot	209 Bordeaux	102 Kirsche	201 Rot
							
125 Tomate	179 Hellrot	180 Terracotta	173 Mango	105 Rost	573 Kupfer	116 Orange	495 Abricot
							
124 Gelb	131 Honig	509 Kamel	550 Ocker	274 Senf	108 Zitrone	403 Mais	535 Sesam
							
203 Vanille	027 Kartause	384 Lind	713 Kiwi	377 Maigrün	732 Farn	378 Oliv	260 Sprießen
							
343 D'Grün	435 Smaragd	625 Pinie	248 Jade	472 Minze	575 Salbei	483 Adria	548 Türkis
							
312 Lagune	345 Pazifik	308 Petrol	698 Dunst	405 Stahl	215 Meer	540 Ozean	533 Indigo
							
282 D'Blau	111 Traube	626 Azur	647 Kobalt	686 Enzian	272 Royal	286 H'Blau	995 Wasser
							
458 Bewölkt	284 Himmel	613 Gletscher	551 Eis	113 Immergrün	099 Lila	667 Amethyst	269 Violett
							
242 Pink	640 Granat	634 Erröten	671 Pfingstrose	255 Flieder	437 Aubergine	250 Trüffelbraun	220 Rehbraun
							
411 Alpaka	190 Natur-meliert	200 Natur	331 Sahara	311 Mandel	467 Sand	481 Sandstein	100 Wollweiß
							
110 Rohweiß	160 Beige	529 Champagner	150 Weiß	428 Silber	427 Stein	021 Beton	170 Asche
							
423 Hellgrau	408 Taupe	175 Graphit	425 Taubengrau	446 Kohle	300 Anthrazit	426 Schwarz	

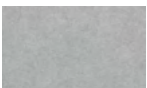
## Akustika 10 Substrate

		
05 Ice	02 Medium Grey	03 Dark Grey